



标准&定制开关连接器产品制造商
DONG GUAN XI BANG ELECTRONICS CO., LTD.

规格书

SPECIFICATION

CUSTOMER NAME 客户名称: _____
 CUSTOMER NO. 客户编号: _____
 SERIES 系列: 按键开关
 MODEL NO. 型号: XB-PS-22F25
 DRAWING NO. 图形号: PS Push Switches

If specification of this product meets your request, please confirm all the items of it and return to us with signature and stamp, it will be basis of our production and record. Thanks your cooperation in advance!

若此产品规格符合贵司要求, 敬请确认此规格书内所有项目
 并签名和盖章后回传给我司, 以作我司产品制作之
 依据和存档之用, 多谢合作!

EXAMINE & APPROVAL 审批

APPROVE 接受	NOT APPROVE 不接受
SIGNATURE 签署 STAMP 盖章 DATE 日期	

PREPARED BY. 制表人	CHECKED BY. 校对	APPROVED BY. 审核	APPROVAL BY. 批准
<div style="border: 1px solid red; padding: 2px;">研发部</div> <div style="border: 1px solid red; padding: 2px;">戴海明</div> <div style="border: 1px solid red; padding: 2px;">2022. 06. 08</div>	<div style="border: 1px solid red; padding: 2px;">品质部</div> <div style="border: 1px solid red; padding: 2px;">黄自清</div> <div style="border: 1px solid red; padding: 2px;">2022. 06. 08</div>	<div style="border: 1px solid red; padding: 2px;">工程部</div> <div style="border: 1px solid red; padding: 2px;">庞军</div> <div style="border: 1px solid red; padding: 2px;">2022. 06. 08</div>	<div style="border: 1px solid red; padding: 2px;">总经办</div> <div style="border: 1px solid red; padding: 2px;">吴量</div> <div style="border: 1px solid red; padding: 2px;">2022. 06. 08</div>

东莞市溪榜电子有限公司

Dong guan Xi Bang Electronics Co., Ltd

地址: 广东省东莞市黄江镇合路工业区

Address: He Lu Industrial Zone, Huangjiang Town, Dongguan City, Guangdong Province

Tel: (0769)82055138/82056828

Fax: (0769)83663452

邮箱: admin@alspr.com switch@alspr.com

http://www.alspr.cn/ http://www.alspr.com/

Dong Guan XB Electronics Co., Ltd

Account Number: 705540238

Bank Name: Citibank N. A., Hong Kong Branch

Country/Region: Hong Kong

Bank Code: 006

Bank Address: 3 Garden Road, Central, Hong Kong

SWIFT/BIC: CITIHKHX (CITIHKHXXXX*If 11 characters are required)

MAil: HK@ALPSR.CN XB@ALPSR.CN

Quality core! Afterburner for Made in China!



CAD FILE:

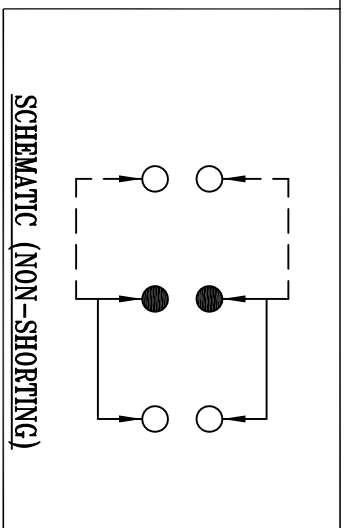
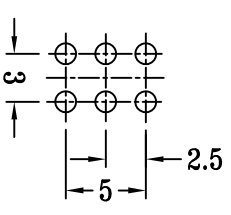
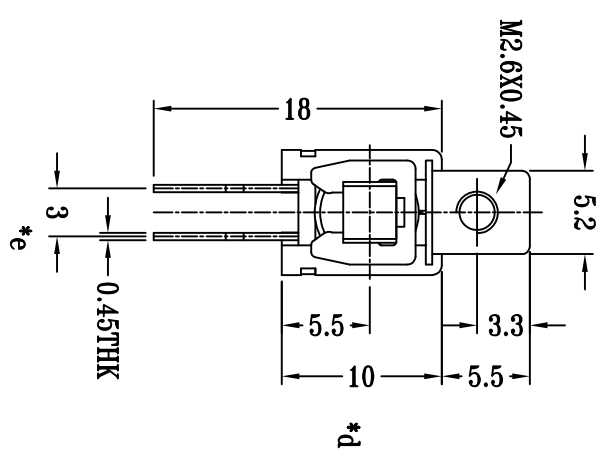
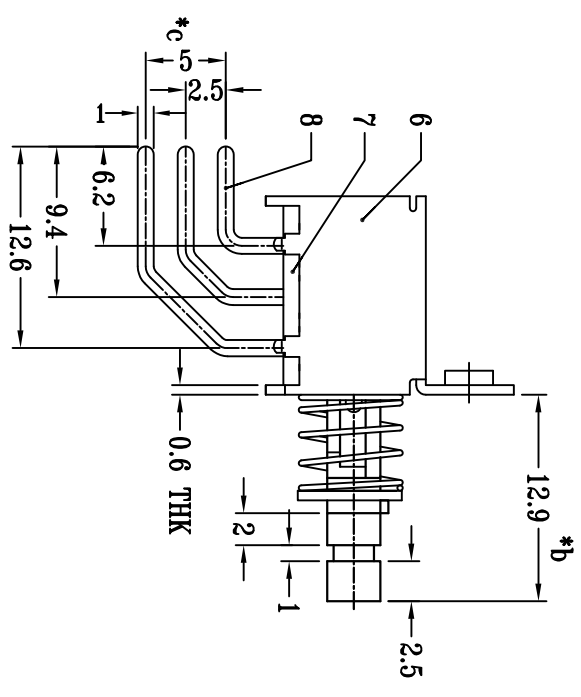
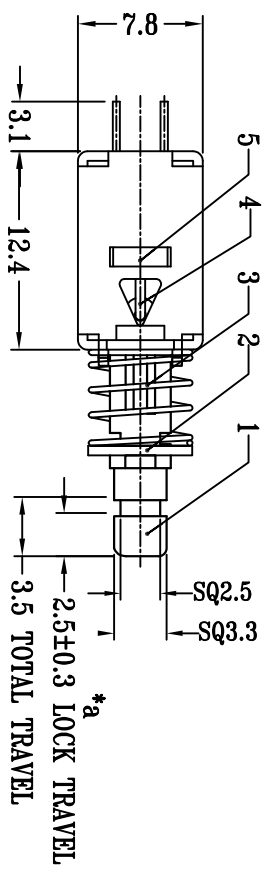

9	CONTACT CLIP	PBS STRIP	2	Ag CLAD
8	TERMINAL	BRASS STRIP	6	Ag PLATED
7	BASE	PHENOLIC RESIN	1	NATURAL
6	FRAME	STEEL STRIP	1	Ni PLATED
5	SPRING PLATE	PBS STRIP	1	NATURAL
4	CAM STICK	PBS WIRE	1	NATURAL
3	SPRING	STEEL WIRE	1	Ni PLATED
2	BLOCK	STEEL STRIP	1	Ni PLATED
1	KNOB	PA66	1	BLACK
NO.	PARTS	MATERIALS	Q'TY	FINISH

TOLERANCE UNLESS SPECIFIED		TITLE : PUSH SWITCH		UNIT : mm	SCALE: 2:1	DRWG NO.: XB-PS-22F25
WITHIN 1.5mm : ±0.1mm OVER 1.5mm : ±0.2mm		ISSUE	DATE	DESCRIPTIONS OF REVISION		
A		2018-10-07	APPD.			
MODEL: XB-PS-22F25		DONG GUAN XI BANG ELECTRONI CS CO., LTD.		CHK'D	APPD.	2018-10-07
DONG GUAN XI BANG ELECTRONI CS CO., LTD.		初版		DWN.	2018-10-07	2018-10-07
X3 Switch Connector		东莞市溪榜电子有限公司		张俊	黄锦效	曾鹏
DONG GUAN XI BANG ELECTRONI CS CO., LTD.		2018-10-07		曾鹏	2018-10-07	2018-10-07

注：“*”表示关键尺寸(5个).



MODEL NO. XB-PS-22F25

产品名称: 侧按式按键开关

DRAWN 制订

吴工

APPD. 审核

庞军

1、RATING (额定值) : DC 30V 0.5A

2、FUNCTION (接触型式) : 2P2T

3、TIMING (时间特性) : NON-SHORTING

4、ELECTRICAL CHARACTERISTICS (电气性能规格)

ITEM 项目		TEST CONDITIONS 测试条件	PERFORMANCE 规格
4.1	CONTACT RESISTANCE 接触电阻	MEASURED AT 1KHz SMALL CURRENT (100mA OR LESS) 在 1KHz 微小电流 (100mA 以下) 测试.	70mΩ MAX. 70 毫欧以下
4.2	INSULATION RESISTANCE 绝缘电阻	APPLY A VOLTAGE OF 250V DC FOR 1 MIN. TO FOLLOWING PORTIONS AFTER WHICH MEASUREMENT SHALL BE MADE. (1) BETWEEN BODY AND TERMINAL. (2) BETWEEN TERMINALS. 输入 250V DC 电压 1 分钟, 按以下接触方法测试: (1) 排脚相互之间。 (2) 排脚与外壳之间。	100MΩ MIN. 100 兆欧以上.
4.3	DIELECTRIC STRENGTH 耐电压	AC 250V rms (50-60Hz) FOR 1 MIN TRIP CURRENT: 0.5mA (1) BETWEEN TERMINALS. (2) BETWEEN INDIVIDUAL TERMINAL AND FRAME. 输入 AC 250V (50-60Hz) 电压, 1 分钟感度电流为 0.5mA, 按以下接触方法测试: (1) 排脚相互之间 (2) 排脚与外壳之间.	WITHOUT DAMAGE TO PARTS ARCING OR BREAKDOWN ETC 没有绝缘破坏等异常

5、MECHANICAL CHARACTERISTICS (机械性能规格)

ITEM 项目		TEST CONDITIONS 测试条件	PERFORMANCE 规格
5.1	OPERATING FORCE 作动力	Push at root of knob 在压柄最顶端测试	180gf ± 50gf
5.2	TERMINAL STRENGTH 端子强度	A STATIC LOAD OF (300gf) SHALL BE APPLIED TO THE TERMINAL FOR 15 SEC, IN ANY DIRECTION. 在排脚前端任意一个方向加 300gf 力度测试, 时 间为 15 秒.	MECHANICAL AND ELECTRICAL CHARACTERISTICS SHALL BE SATISFIED WITHOUT LOOSENESS OF ACTUATOR. 在端子中没有裂开, 松动等 异常, 满足于机械、电器性 能。

6、ENDURANCE CHARACTERISTICS (耐久性) :

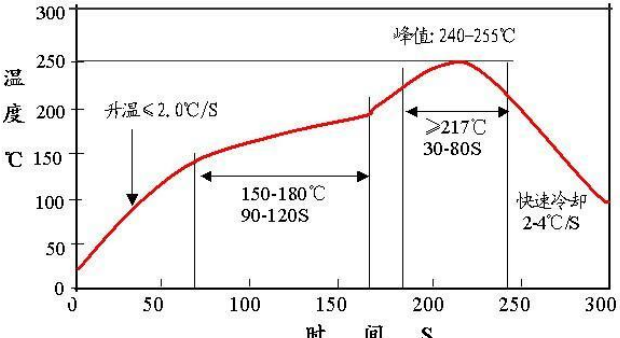
ITEM 项目	TEST CONDITIONS 测试条件	PERFORMANCE 规格
6.1 LIFE TEST 寿命试验	WITHOUT LOAD: AN ACTUATOR SHALL BE SUBJECT TO 10,000 CYCLES AT A SPEED OF 15 TO 18 CYCLES FOR 1 MIN. 无负荷: 操作者以每分钟 15—18 回的频率作 10,000 回之无负荷测试。	(1) CONTACT RESISTANCE SHALL BE 200mΩ MAX. (2) MECHANICAL AND ELECTRICAL CHARACTERISTICS SHALL BE SATISFIED. (1) 接触电阻不能超于 200mΩ. (2) 其它、满足于机械、电器性能。
6.2 SOLDERABILITY TEST 可焊性试验	THE TOP OF THE TERMINALS SHALL BE DIPPED 2mm IN THE SOLDER BATH OF 240±5°C FOR 3±0.5 SECONDS. 端子顶部被浸入锡焊池中 2mm 深, 温度为 240±5°C, 时间为 3±0.5 秒。	THE AREA OF SOLDERING SHOULD BE OVER 95% 焊接面积要有 95% 以上。
6.3 RESISTANCE TO SOLDERING HEAT TEST 耐焊性试验	(1) Hand welding: 380°C Max. 3sec. Max. (2) Reflow soldering: 	THERE SHALL BE NO DEFORMATION OR CRACKS IN MOLDED PART. 外观无异常, 满足于机械、电器性能。
6.4 HEAT TEST 耐热试验	THE SWITCH SHALL BE STORED AT A TEMPERATURE OF 85±2°C FOR 96 HOURS. THEN THE SWITCH SHALL BE MAINTAINED AT STANDARD ATMOSPHERIC CONDITIONS FOR 1 HOUR AFTER WHICH MEASUREMENT SHALL BE MADE. 放置在温度 85±2°C 中测试 96 小时后, 再将放置在常温常湿的环境中 1 小时后进行测试。	
6.5 COLD TEST 耐冷试验	THE SWITCH SHALL BE STORED AT A TEMPERATURE OF -25±3°C FOR 96 HOURS. THEN THE SWITCH SHALL BE MAINTAINED AT STANDARD ATMOSPHERIC CONDITIONS FOR 1 HOUR AFTER WHICH MEASUREMENT SHALL BE MADE. 放置在温度 -25±3°C 中 96 小时后, 再将放置在常温常湿的环境中 1 小时后进行测试。	

 东莞市溪榜电子有限公司 DONG GUAN XI BANG ELECTRONICS CO., LTD.		文件编号	XB-58-20010608
		发布日期	2001年06月08日
SPECIFICATION 规格书		第 A 版	第 3 页 共 3 页
ITEM 项目		TEST CONDITIONS 测试条件	PERFORMANCE 规格
6.6	HUMIDITY TEST 潮湿试验	<p>THE SWITCH SHALL BE STORED AT A TEMPERATURE OF $40 \pm 2^{\circ}\text{C}$ AND A HUMIDITY OF 90% TO 95% FOR 96 HOURS. THEN THE SWITCH SHALL BE MAINTAINED AT STANDARD ATMOSPHERIC CONDITION FOR 1 HOUR AFTER WHICH MEASUREMENT SHALL BE MADE.</p> <p>放置 $40 \pm 2^{\circ}\text{C}$ 的相对湿度为 90%~95% 环境中 96 小时后, 再将放置在常温常湿的环境中 1 小时后进行测试.</p>	<p>THERE SHALL BE NO DEFORMATION OR CRACKS IN MOLDED PART.</p> <p>外观无异常, 满足于机械、电器性能.</p>
6.7	STANDARD ATMOSPHERE CONDITIONS 测试标准状态	<p>UNLESS OTHERWISE SPECIFIED. THE STANDARD RANGE OF ATMOSPHERE CONDITIONS FOR MAKING MEASUREMENTS AND TESTS ARE AS FOLLOWS:</p> <p>(1) AMBIENT TEMPERATURE: 5°C TO 35°C (2) RELATIVE HUMIDITY: 45% TO 85% (3) AIR PRESSURE : 86Kpa TO 106Kpa</p> <p>在没有指定的情况下测试温度、湿度、气压如下:</p> <p>(1) 温度为 5°C—35°C. (2) 湿度为 45%—85%. (3) 气压为 86Kpa—106Kpa.</p>	
6.8	PRACTICAL TEMPERATURE RANGE 使用温度范围	<p>$-16^{\circ}\text{C} \sim +60^{\circ}\text{C}$. 在 $-16^{\circ}\text{C} \sim +60^{\circ}\text{C}$ 温度内使用.</p>	
7.0	STORAGE ENVIRONMENT 储存环境	<p>(1) UNDER SEALING PACK CONDITION, STORED TEMPERATURE DON'T EXCEED 30°C AND RELATIVE HUMIDITY IS 75% RH; IN THE ENVIRONMENT OF NO SUNSHINE DIRECT AND NO CORROSIVE GAS, THE STORED TIME OUGHT TO BE THREE MONTHS BUT WITHIN SIX MONTHS AT MOST.</p> <p>(2) WITHOUT SEALING PACK CONDITION, STORED TEMPERATURE DON'T EXCEED 30°C AND RELATIVE HUMIDITY IS 75% RH; IN THE ENVIRONMENT OF NO SUNSHINE DIRECT AND NO CORROSIVE GAS, THE STORED TIME SHOULD NOT EXCEED 48H.</p> <p>(3) DON'T EXCESSIVE OVERLAP OR OVERSTOCKING WHEN KEEPING THIS GOODS, IN CASE OF DAMAGE.</p> <p>(1) 密封包装状态下, 储存温度为 $\leq 30^{\circ}\text{C}$, 相对湿度 75% RH, 无阳光直射, 无腐蚀性气体的环境中, 储存时间为 3 个月, 最长不宜超过 6 个月。 (2) 无密封包装状态下, 储存温度为 $\leq 30^{\circ}\text{C}$, 相对湿度 75% RH, 无阳光直射, 无腐蚀性气体的环境中, 储存时间最长不宜超过 48 小时。 (3) 保存时应注意物品不能过量重叠、积压, 以免损坏。</p>	<p>THERE SHALL BE NO DEFORMATION OR CRACKS IN MOLDED PART.</p> <p>外观无异常, 满足于机械、电器性能.</p>