

RoHS

REV.	EC#	DESCRIPTION	DATE	DRAWING	CHECKED	APPROVED
A0	ECN1803014	PT版新版发行	26/03'18	SUPER	SKY	WU
A1	ECN1811022	切换成小力臂	11/30'18	TEDDY		LHY

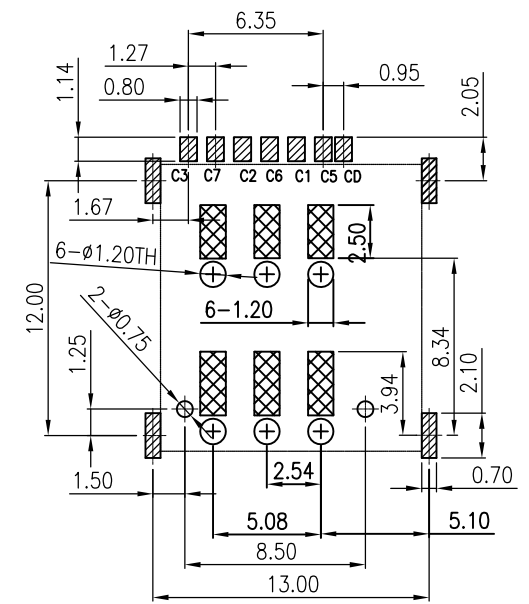

RECOMMENDED PCB LAYOUT
GENERAL TOLERANCE ±0.05

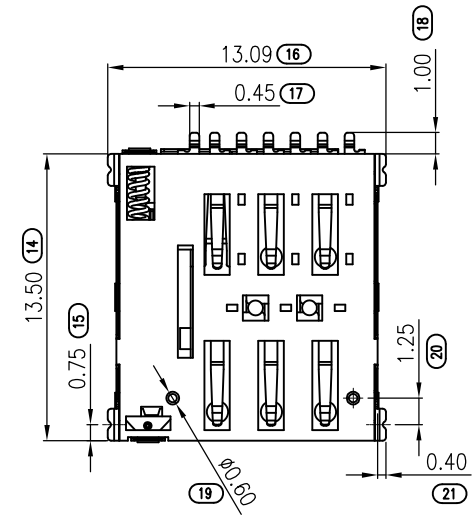
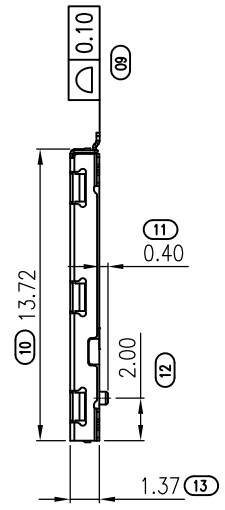
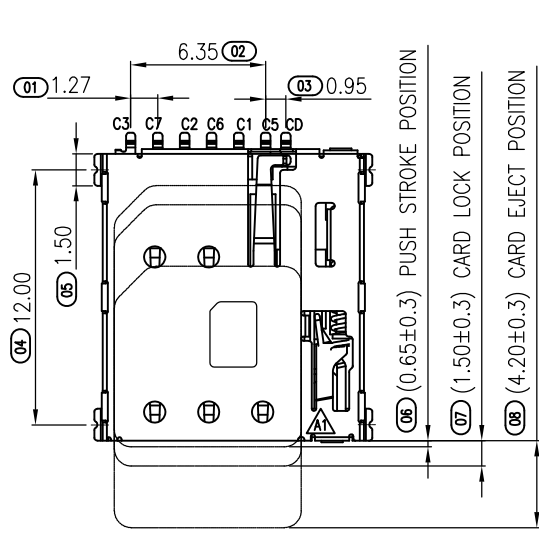
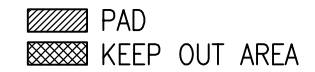

- NOTES:
- MATERIAL:
HOUSING:HI-TEMP. PLASIC UL 94V-0
CONTACT: COPPER ALLOY
SHELL: STAINLESS STEEL
 - PLATING :
TERMINAL:
CONTACT AREA: Au GOLD FLASH.
SOLDER AREA: AU GOLD FLASH.
UNDER PLATE: NICKEL.
SHELL: NICKEL PLATED OVER ALL.
SOLDER AREA: GOLD FLASH.
 - SPECIALITY:
3.1 Rated current:1.0A
3.2 Rated voltage:30V
3.3 Contact Resistance:50mΩ MAX
3.4 Insulation Resistance:1000MΩ MIN 500V DC
3.5 Dielectric withstanding voltage: 500V AC.
3.6 Solder ability:260+0/-5°C, 30±10s.
3.7 Durability:5000 Cycles Min.
3.8 Operating condition:Temperature-40°C~+85°C;
Humidity 80% R.H MAX

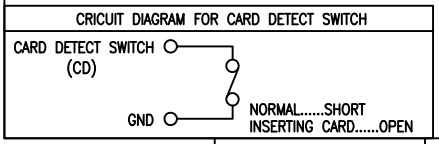
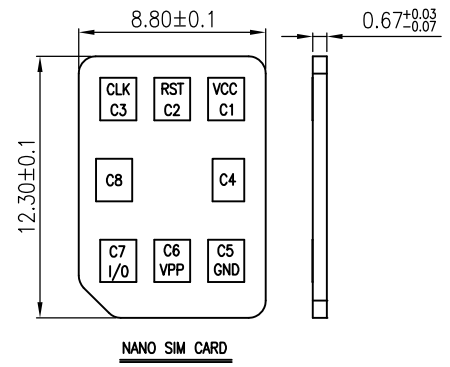
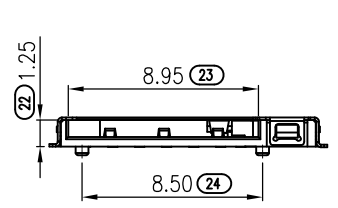

SIM pin Assignment		MILLIMETERS	INCH	UNITS	MM
PIN#	Name	X° ± Z'	X° ±	MAT'L	
C1	VCC	.X ± 0.30	.XX ±	SEE NOTES	
C2	RST	.XX ± 0.20	.XXX ±	FINISH	
C3	CLK	.XXX ± 0.10	.XXXX ±	SEE NOTES	
C5	GND			QTY	
C6	VPP			SEE NOTES	
C7	I/O				

XGB 东莞市溪榜电子有限公司
DONG GUAN XI BANG ELECTRONI CS CO., LTD.

PART NUMBER: XB-102312402
TITLE: NANO SIM CARD PUSH PUSH 7PIN 1.37H 带CD PIN PT版

APPD: DWG NO.: C-102312402-00

CHKD: SCALE: 1:1
DR: SHEET: 1/2
REV: A1

RoHS

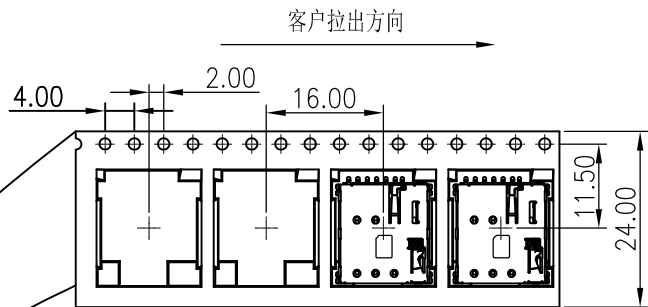

客户拉出方向

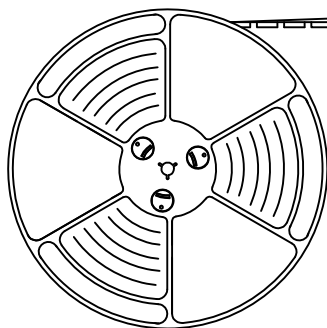

NOTES

1. 每卷包装数量:1500PCS/每卷
2. 卷带包装方式:

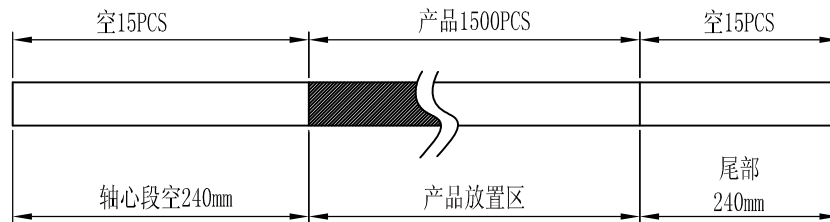

3. 每箱包装数量:15000PCS/箱
4. 纸箱350mm*350mm*340mm(内部尺寸), 材质K=K

PE袋

纸箱底部和顶部各垫一块珍珠棉

护角

纸箱

封箱胶带“工”字形封好

绿色环保标签 RoHS

产品标签贴在纸箱左上角

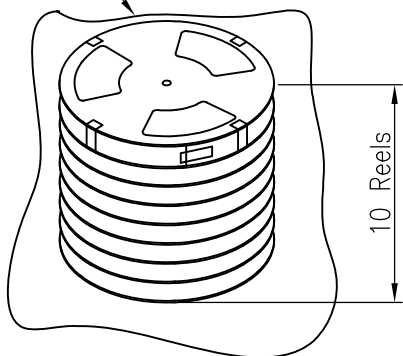

将10卷产品放入箱内

MILLIMETERS	INCH	UNITS	MM	XIB 东莞市溪榜电子有限公司 DONG GUAN XI BANG ELECTRONICS CO., LTD.		
X° ± 2'	X° ±	MAT'L		PART NUMBER: XB-102312402		TITLE: NANO SIM CARD PUSH PUSH 7PIN 1.37H WITH CD PIN PT版
.X ± 0.30	.XX ±	SEE NOTES		APPD:		DWG NO.: C-102312402-00
.XX ± 0.20	.XXX ±	FINISH		CHKD:		SCALE SHEET REV. 1:1 2/2 A1
.XXX ± 0.10	.XXXX ±	SEE NOTES		DR:		
		QTY				
		SEE NOTES				