

P. C. B Layout (Top view)

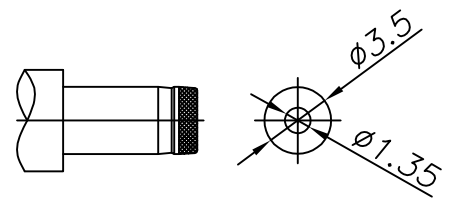

DC MATE PLUG

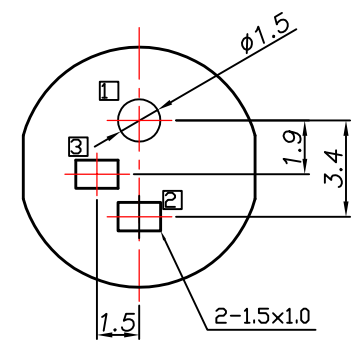
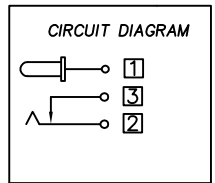
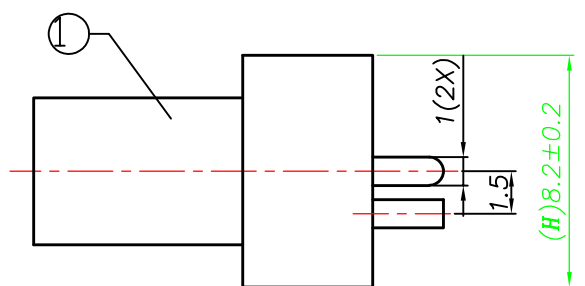

NO.	PART NAME	MATERIAL	QTY	FINISHING
5	FLAT PIECE	BRASS	1	Au PLATED
4	SPRING	PHOSPHOR BRONZE	1	Au PLATED
3	PIN	BRASS	1	Au PLATED
2	COVER	PA66	1	BLACK
1	CASE	PA66	1	BLACK

UNLESS OTHERWISE SPECIFIED TOLERANCES

XGB 东莞市溪榜电子有限公司
DONG GUAN XI BANG ELECTRONICS CO., LTD.

DESIGN:	Tony	PART NAME:	Φ3.5XΦ1.35
CHECK:		DC POWER JACK	
APPROVED:	Andy	PART NO.:	DC350135-0567-20000H
UNIT:	mm	SHEET:	1/1
3RD ANGLE PROJECTION		REV.:	A1
		DRAWING NO	

REV.	ECN NO.	DESCRIPTION	DESIGN	DATE

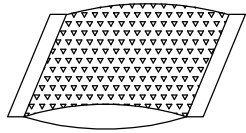
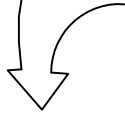
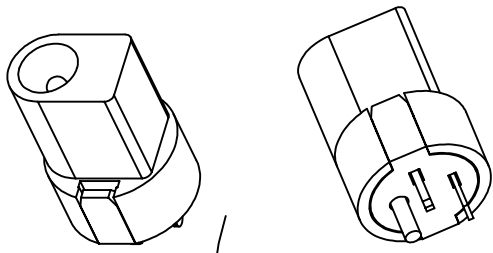

规格: 220X190mm
500PCS/bag

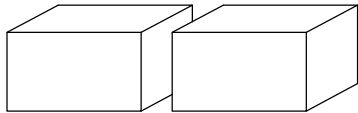
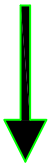

规格: 16X13X8mm
1bag/1box

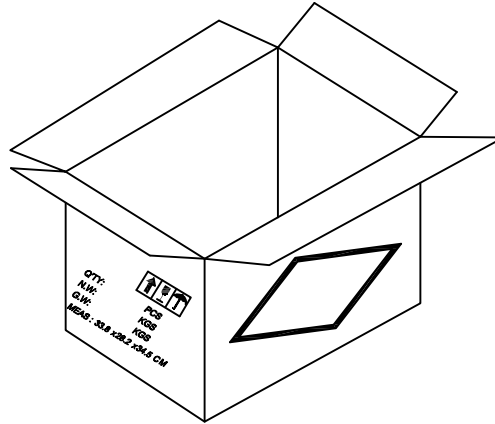
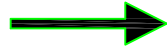

规格: 33.8*28.2*34.5cm

NOTE:

1. PE袋与纸箱尺寸如图所示.
2. 将产品放入PE袋内,每袋放500PCS装小盒.
3. 一大箱每层放4小盒., 装20小盒, 共10000PCS.
4. PE袋内装合格标签和贴RoHS标签, 包装箱贴成品标签
及RoHS标签(依客户需求而定).

REV.	ECN NO.	DESCRIPTION	DESIGN	DATE
------	---------	-------------	--------	------

UNLESS OTHERWISE SPECIFIED TOLERANCES				东莞市溪榜电子有限公司 DONG GUAN XI BANG ELECTRONICS CO., LTD.	
DECIMALS:		ANGLES:		DESIGN:	Tony
DIM	TOL	DIM	TOL		2019.7.22
X.	±0.50	X.	±2°	CHECK:	
X.X	±0.30	X.X	±1°		
X.XX	±0.20	X.XX	—		
X.XXX	±0.10	X.XXX	—		
3RD ANGLE PROJECTION				UNIT:	APPROVED
				mm	Andy
					2019.7.22
				PART NAME:	
				Φ3.5XΦ1.35	
				DC POWER JACK-包装图	
				PART NO.	
				DC350135-0567-20000H	
				SHEET: 1/1	REV.: A1
				DRAWING NO	

8

7

6

5

4

3

2

1

F
E
D
C
B
A