

MATING PLUG
P/N: DP350135-0120-60000H

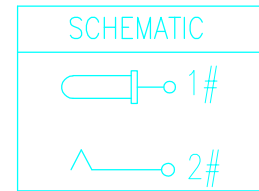

SPECIFICATION

1. Rating : DC 12V, 3.0A;
2. Contact resistance: 30mΩ MAX;
3. Insulation resistance: 100MΩ MIN.;
4. Withstand voltage: 500VAC ;
5. Insertion and extraction force: 3-20N
6. life test: 5,000 cycles.

RECOMMENDED PCB LAYOUT
TOP VIEW TOLERANCE:±0.05

D	PIN	1	HBI59	Gold flash/Ni
C	CURVE PIECE	1	SUS 304	Ni
B	SPRING	1	C5191	Sn/Ni
A	HOUSING	1	PA46 BLACK	
NO.	DESCRIPTION	QTY	MATERIAL	PLATING

UNLESS OTHERWISE SPECIFIED TOLERANCES		东莞市溪榜电子有限公司 DONG GUAN XI BANG ELECTRONICS CO., LTD.	
DECIMALS:	ANGLES:	DESIGN:	Tony
DIM	TOL	DIM	TOL
X.	±0.50	X.	±2°
X.X	±0.30	X.X	±1°
X.XX	±0.20	X.XX	
X.XXX	±0.10	X.XXX	
3RD ANGLE PROJECTION		UNIT:	mm
CHECK:		APPROVED	Andy
PART NAME:		2021.9.1	
Φ3.50X1.35 卧式 DC POWER JACK			
PART NO.			
XB-DC350135-0831-20000H			
SHEET: 1/1		REV.: A1	
DRAWING NO			

REV.	ECN NO.	DESCRIPTION	DESIGN	DATE
------	---------	-------------	--------	------

8

7

6

5

4

3

2

1

拉出方向

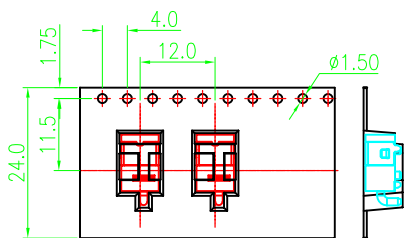

拉出方向

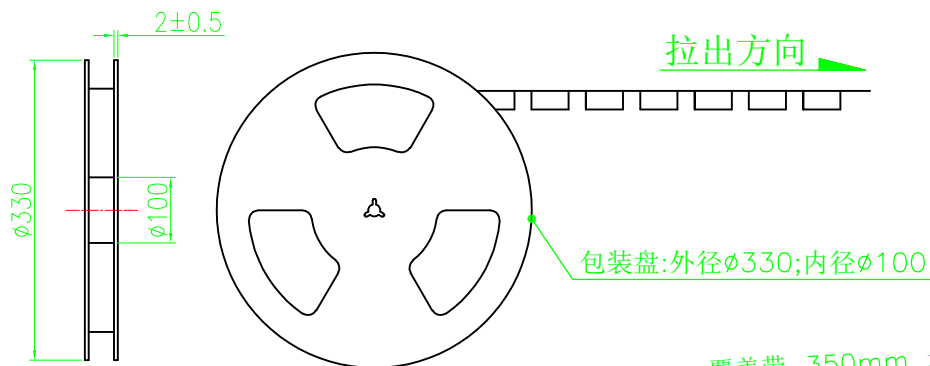

包装盘:外径 ϕ 330;内径 ϕ 100

覆盖带 350mm 最少.

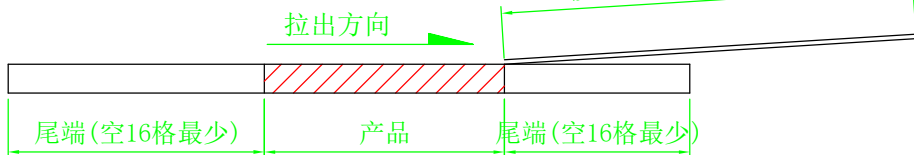

包装盘标签

总共10层

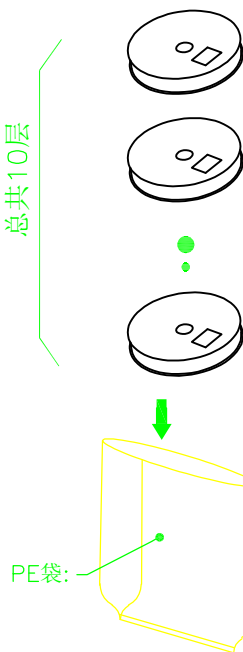

PE袋:

外箱,1PCS

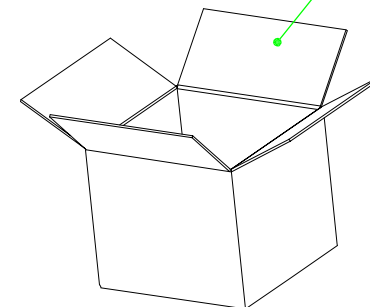

透明胶带

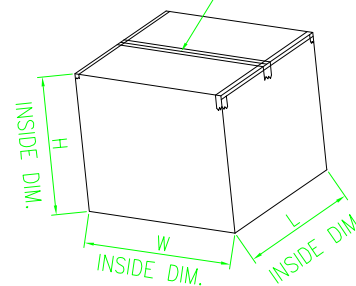

备注:

1. 材料规格:
 - 1.1 载带:T=0.40mm
 - 1.2 包装盘:蓝色
 - 1.3 纸箱: L=335,W=335,H=300
2. 包装数量:

800PCS/卷, 10卷(8000PCS)/箱
3. 上盖带拔离力: 0.1N~0.7N(10~70gf);

拔离角度: 165°~180°;
拔离速度: 300mm/分钟.

UNLESS OTHERWISE SPECIFIED TOLERANCES				东莞市溪榜电子有限公司 DONG GUAN XI BANG ELECTRONICS CO., LTD.			
DECIMALS:		ANGLES:		DESIGN:	Tony	PART NAME:	
					2021.9.27	Φ3.50 卧式	
DIM	TOL	DIM	TOL	CHECK:		DC POWER JACK-包装图	
x.	///	x.	///			PART NO.	
x.x	///	x.x	///			XB-DC350135-0831-20000H	
x.xx	///	x.xx	///			SHEET: 1/1 REV.: A1	
x.xxx	///	x.xxx	///			DRAWING NO	
3RD ANGLE PROJECTION				UNIT:	APPROVED	Andy-Liu	
				mm		2021.9.27	

REV.	ECN NO.	DESCRIPTION	DESIGN	DATE
------	---------	-------------	--------	------

8

7

6

5

4

3

2

1