

F E D C B A

RoHS  
Compliant

SYMBOL	REVISION	APPROVAL	DATE

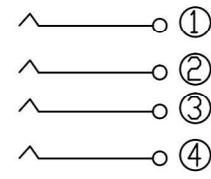
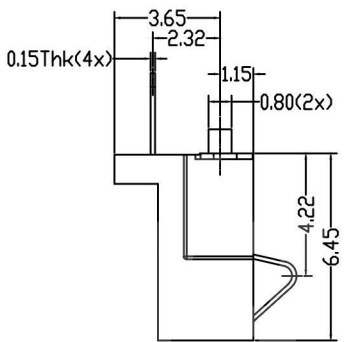
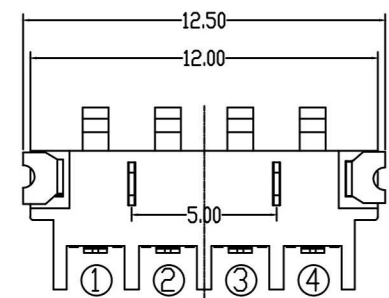

CIRCUIT

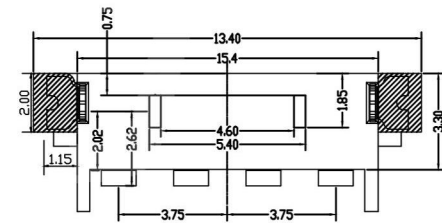
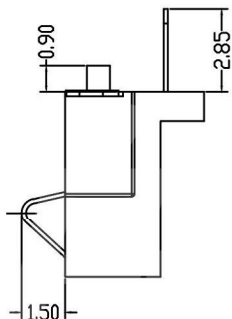
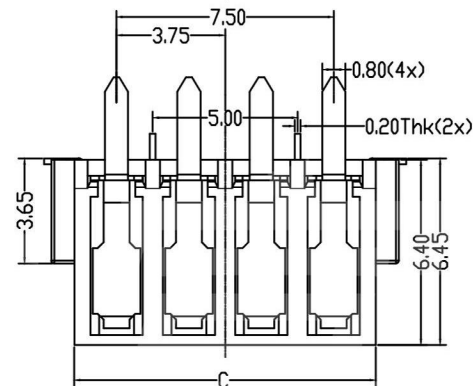

PCB LAYOUT(3pin)

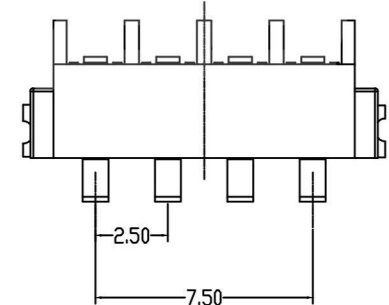

3	PEG	BRASS	1	Sn PLATED
2	HOUSING	LCP	1	BLACK
1	TERMINAL	BeCu	3	Au PLATED
NO.	PARTS	MATERIAL	QTY.	FINISHING

**XB** 东莞市溪榜电子有限公司  
DONG GUAN XI BANG ELECTRONICS CO., LTD.

PART NAME	CONNECTOR			DRAWING	DWG.No.	SBICL
PART NO.	XB-BC-25S-4P-L			CHECK	REV.	A1
UNIT : mm	TOLERANCE	UP TO 5 ±0.2	ANGLE	APPROVAL	DATE	13-07-2019
	OTHERWISE	ABOVE 5 ~30 ±0.3	0°±3°	SCALE	PAGE	1 OF 1

F E D C B A